

REV.	ECN NO.	MODIFY MATTER	DATE	APPROVED
A		RELEASE TO PRODUCTION		

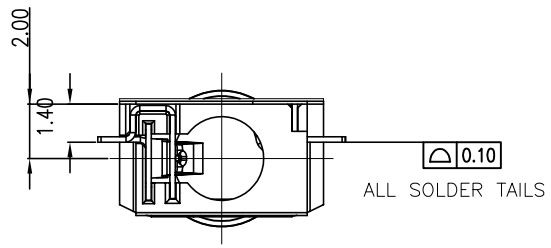

- NOTES:
- CONTACT CURRENT RATING: 1A.
  - CONTACT RESISTANCE: 50 mΩ MAX.;
  - INSULATION RESISTANCE: 100MΩ MIN.;
  - DIELECTRIC WITHSTANDING: 500V AC MIN.;
  - DURABILITY: 5,000 CYCLES MIN.;
  - CONNECTOR MATING FORCES: 29.4N (3.00Kgf) MAX.;
  - CONNECTOR UNMATING FORCES: 2.94N(0.30Kgf) MIN.;

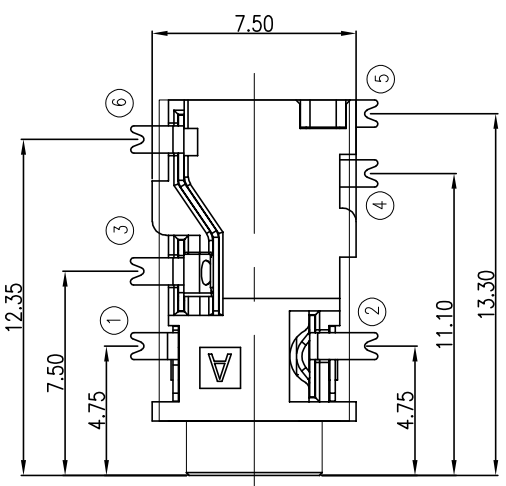
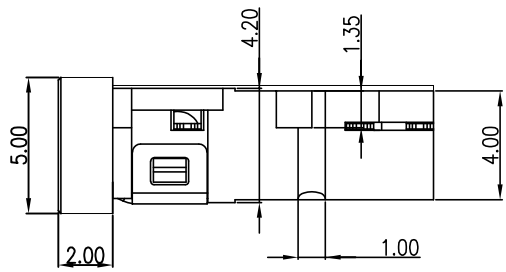
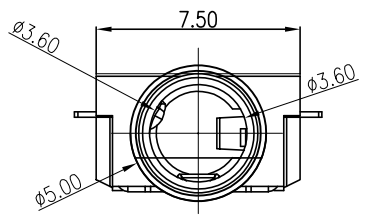
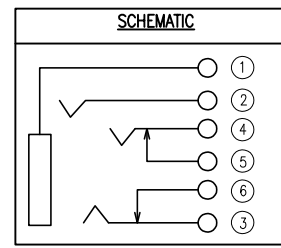

EAST-2308A-06FB-APA

B:BLACK  
P:PINK  
G:GREEN

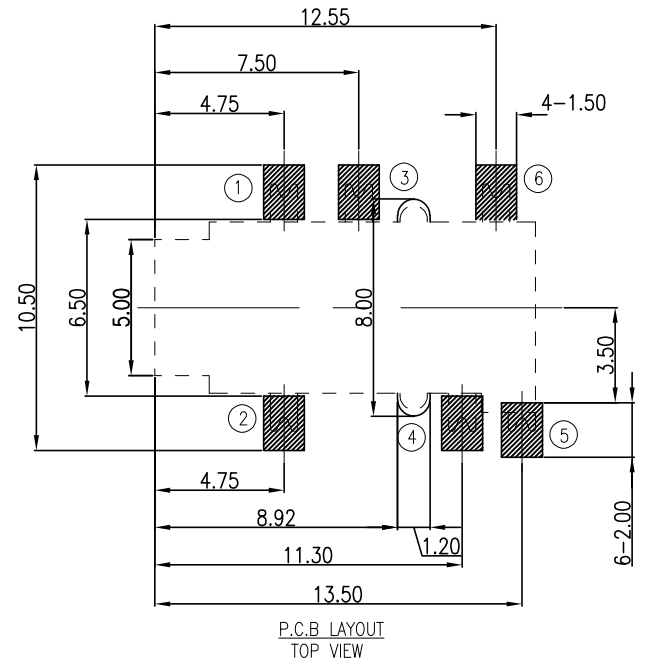
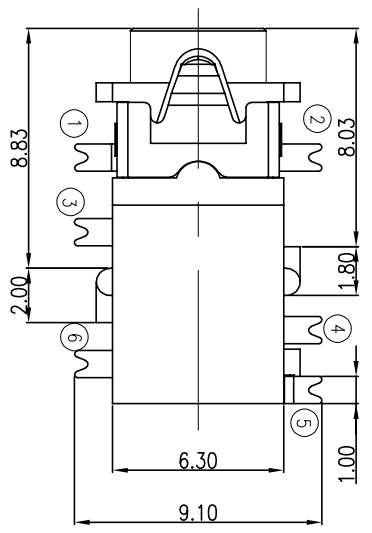

ITEM	PART NAME	Q'TY	MATERIAL	DESCRIPTION	REMARK
⑦	HOUSING	1	LCP		Black
⑥	CONTACT F	1	PHOSPHOR BRONZE 0.20T	Au PLATED	
⑤	CONTACT E	1	BRASS 0.20T	Au PLATED	
④	CONTACT D	1	PHOSPHOR BRONZE 0.20T	Au PLATED	
③	CONTACT C	1	PHOSPHOR BRONZE 0.20T	Au PLATED	
②	CONTACT B	1	PHOSPHOR BRONZE 0.20T	Au PLATED	
①	CONTACT A	1	PHOSPHOR BRONZE 0.20T	Au PLATED	

TOLERANCES UNLESS OTHERWISE SPECIFIED:  
X. X ± 0.38  
X. XX ± 0.25  
X. XXX ± 0.10  
Angle ± 1°

THESE DRAWING AND SPECIFICATION ARE THE PROPERTY OF Shenzhen Dongfongyue ELECTRONIC CO., LTD., SHALL NOT BE REPRODUCED.

CUSTOMER COPY  
DRAWN: CHENLEI  
CHECKED: CHENLEI  
APPROVED: QINKAIXING

深圳市东方御业科技有限公司  
WWW.DFYCONN.COM TEL:0755-27155560

TITLE: 3.5mm PHON JACK 4 PORT (RoHS)

PART NO: EAST-2308A-06FB-APA

UNIT: mm  
SCALE: N/A  
SHEET: 1:1  
REV.