

REV	LTR	DESCRIPTION	DATE	DWN

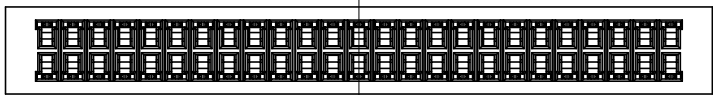
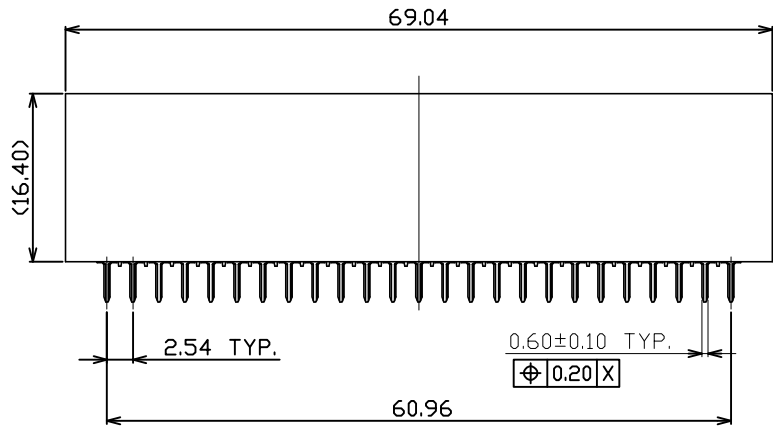
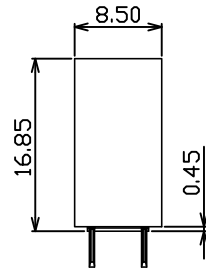
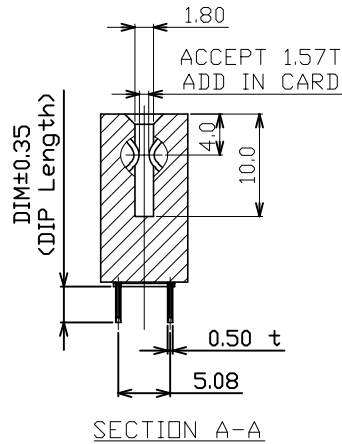
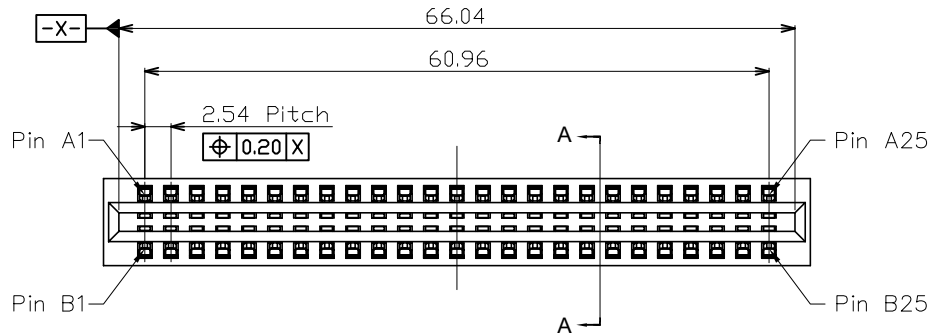

***Material:**

- Housing: HIGH TEMP. THERMOPLASTIC, UL94V-0,COLOR: BLACK,;
- Terminal: COPPER ALLOY;
Plating: Gold on contact area;
80u" Min Tin on solder area;
30u" MIN.NICKEL UNDERPLATING OVER ALL.

***Electrical Characteristics:**

- Operating Voltage: 100V Max.;
- Current Rating: 9.0A Per Contacts;
- Insulation Resistance: 1000MΩ Min.
- Dielectric Strength: 750V DC/1MIN.

***Mechanical Characteristics:**

- Insertion Force: 3N per contact pair Max.
- Extraction Force: 0.3N per contact pair Min.
- Durability rating: 200 Cycles

*Operating temperature: -40°C ~ +105°C;

*ALL MATERIAL SHOULD BE FULFILLED ROHS COMPLIANT.

ORDER INFORMATION:

EAST-050 A1 X 11 X X X X

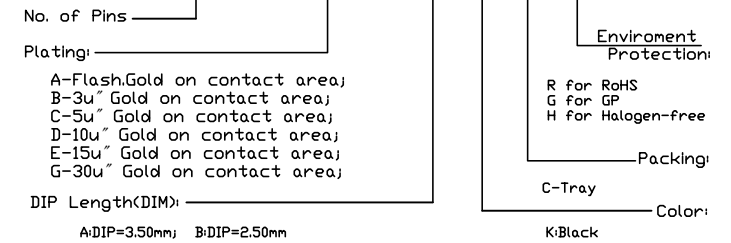

- A-Flash Gold on contact area;
- B-3u" Gold on contact area;
- C-5u" Gold on contact area;
- D-10u" Gold on contact area;
- E-15u" Gold on contact area;
- G-30u" Gold on contact area;

DIP Length(DIM):

A:DIP=3.50mm; B:DIP=2.50mm

Packing:

C-Tray

Color:

K:Black

TOLERANCE		深圳市东方御业科技有限公司 ShenZhen CHNEAST Technology co.,Ltd	TITLE: 2.54mm Edge Card V/T DIP 50Pin Power Connector				
LINEAR	ANGLES		CUSTOMER COPY	PART NO.:	SEE TABLE	DWG NO.:	
X.±0.50	X°.±2.0°	APPD:	DRWN: Rocky	UNITS	SCALE	SHEET	REV
.X ±0.38	.X°±1.0°						
.XX ±0.25	.XX°±	CHKD:	DATE: 2023-10-10				
.XXX ±0.15	.XXX°±						

REV	LTR	DESCRIPTION	DATE	DWN

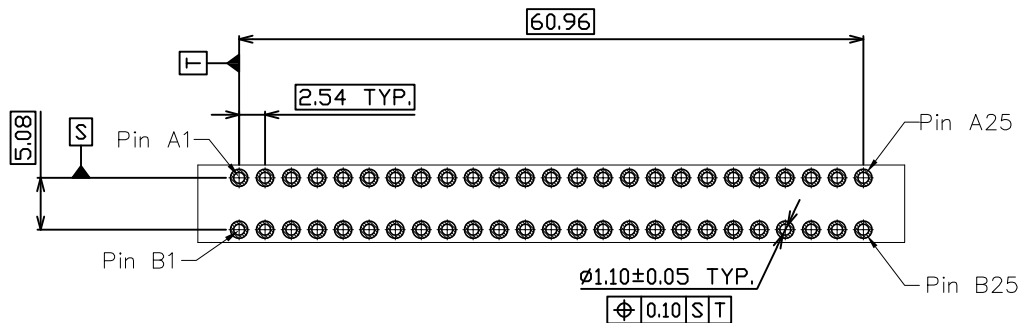
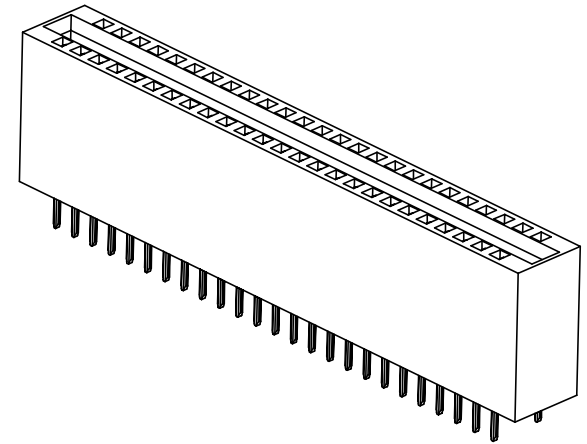
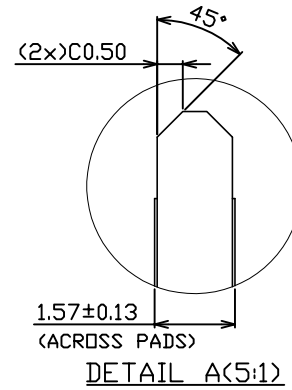
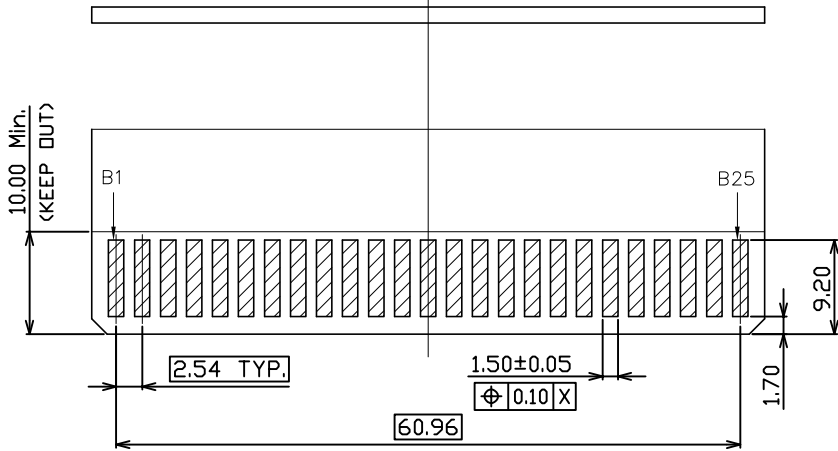
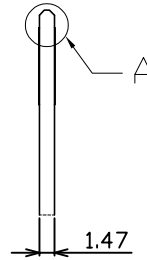
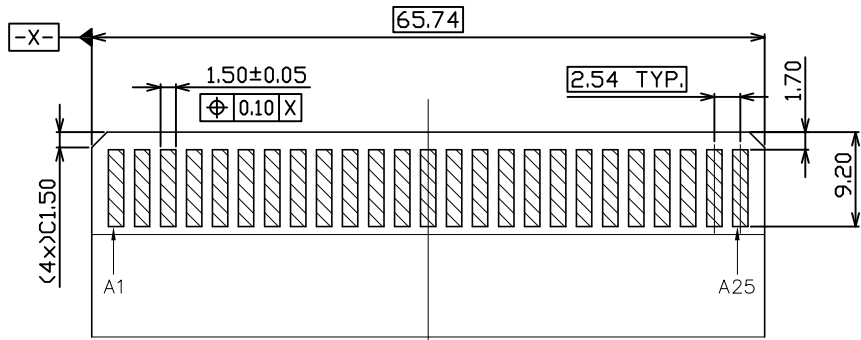

RECOMMEND P.C.B LAYOUT(TOP VIEW)
TOLERANCE:±0.05

TOLERANCE		深圳市东方御业科技有限公司 ShenZhen CHNEAST Technology co.,Ltd	TITLE: 2.54mm Edge Card V/T DIP 50Pin Power Connector				
LINEAR	ANGLES		CUSTOMER COPY	PART NO.: SEE TABLE			
X.±0.50	X°.±2.0°		DWG NO.: EAST-A1-11				
.X±0.38	.X°.±1.0°	APPD:	DRWN: Rocky	UNITS	SCALE	SHEET	REV
.XX±0.25	.XX°±	CHKD:	DATE: 2023-10-10	MM	1:1	2 OF 2	0.1
.XXX±0.15	.XXX°±						