

# HDMI CONNECTOR FEMALE

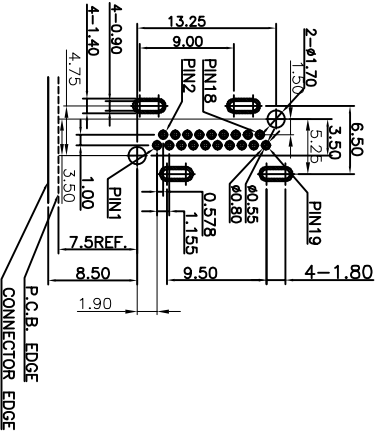
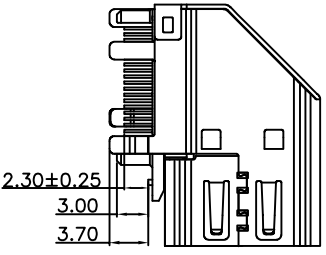
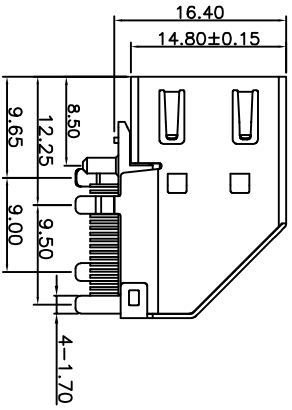
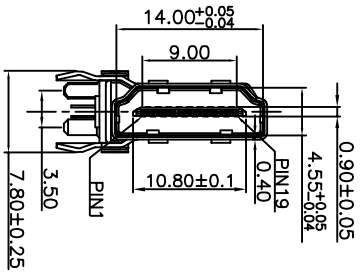
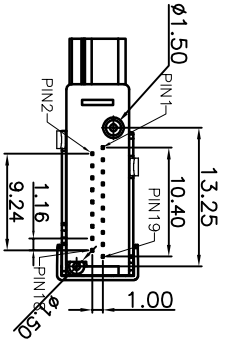
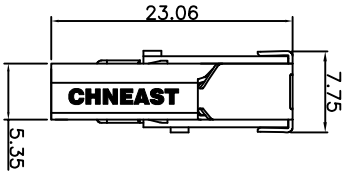

RECOMMENDED PCB LAYOUT (TOP VIEW)

TOLERANCE: ±0.05mm

## SPECIFICATIONS:

- ELECTRICAL CHARACTERISTICS
  - CURRENT RATING: 0.5 AMP
  - VOLTAGE RATING: 40 V
  - CONTACT RESISTANCE: 30MILLIOHMS MAX
  - INSULATION RESISTANCE: 100M MIN. @500V DC
  - DIELECTRIC WITHSTANDING VOLTAGE: 500V AC FOR 1 MINUTE
- MECHANICAL CHARACTERISTICS:
  - INSERTION FORCE: 4.5KGF MAX.
  - WITHDRAWING FORCE: 1KGF ~ 4KGF.
  - LIFE TEST: 10000 CYCLES
  - OPERATING TEMPERATURE: -45°C TO +105°C
  - PART NO. DESCRIPTION:
  - P/N

EAST-HD6630X0002

TERMINAL PLATING CODE:

- A: CONTACT AREA: GOLD FLASH
- SOLDER AREA: MATTE TIN 100u"
- B: CONTACT AREA: 5u" GOLD
- SOLDER AREA: MATTE TIN 100u"
- 1: CONTACT AREA: GOLD FLASH
- SOLDER AREA: GOLD FLASH

NO	PART NAME	QTY	MATERIAL PLATING & COLOR
C	SHELL	1	C2680R-H Ni 50u" T=0.4mm PLATING ALL OVER
B	TERMINAL	19	C2680R-H, T=0.2±0.02mm
A	HOUSING	1	LCP E130I UL94V-0 BLACK

深圳市东方御业科技有限公司

WWW.DFYCONN.COM TEL:0755-27155560

DRINK: CUSTOMER COPY

DRAWN: 2017/09/10

CHECKED: 2017/09/10

APPROVED: 2017/09/10

UNIT: mm

SCALE: N/A

SHEET: 1:1

REV:

OTHERWISE SPECIFIED:  
X  
X.X  
X.XX  
X.XXX  
Angle ±1°

TOLERANCES UNLESS OTHERWISE SPECIFIED:  
X  
X.X  
X.XX  
X.XXX  
Angle ±1°

THESE DRAWING AND SPECIFICATION ARE THE PROPERTY OF Shenzhen Dongfangyue ELECTRONIC CO., LTD. SHALL NOT BE REPRODUCED.

UNIT: mm  
SCALE: N/A  
SHEET: 1:1  
REV:

REV.	ECN NO.	MODIFY MATTER	DATE	APPROVED
A		RELEASE TO PRODUCTION		

每20盒用PE 横缠绕包扎紧

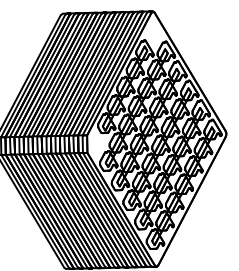
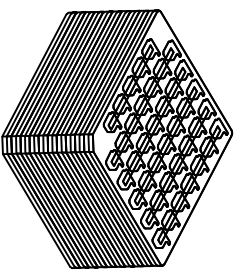

左右各800PCS  
共计：1600PCS

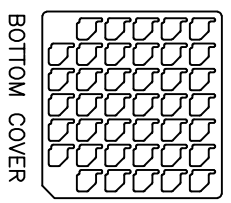
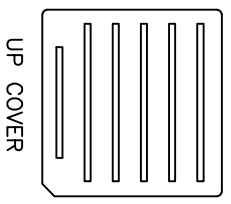

40PCS/TRAY

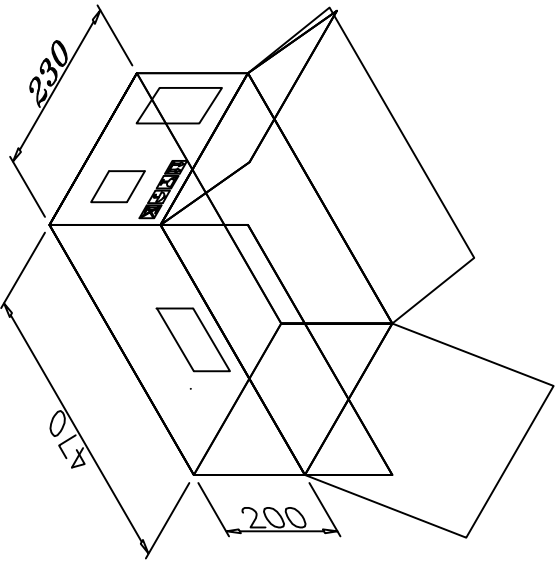
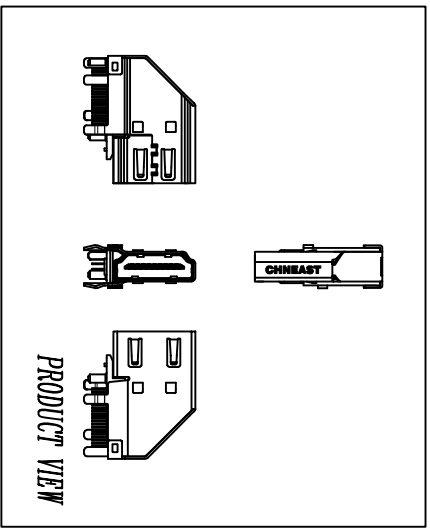

NOTE:  
1. PACKING: 40PCS/TRAY, 1600PCS/CARTON.  
2. CARTON SIZE: 470\*230\*200mm

TOLERANCES UNLESS OTHERWISE SPECIFIED:		COSTOMER COPY		深圳市东方御业科技有限公司 WWW.DFYCONN.COM TEL:0755-27155560	
X	± 0.38	DRAWN:		DATE:	2017/09/10
X.X	± 0.25	CHECKED:	CHENLEI	DATE:	2017/09/10
X.XX	± 0.10	CHECKED:	CHENLEI	DATE:	2017/09/10
X.XXX	± 1°	APPROVED:	QINMAYING	DATE:	2017/09/10
Angle		UNIT:	mm	SCALE:	N/A
THESE DRAWING AND SPECIFICATION ARE THE PROPERTY OF Shenzhen Dongfangyue Electronic Co., Ltd. SHALL NOT BE REPRODUCED.		PART NO:	HDMI 侧插铜壳镀锡两脚两直脚 两脚间距7.80 针长2.3, 端子半金雾锡1u* (ReHS)		